



infomir  
3D PRINTING



# HOW TO PREPARE A MODEL FOR 3D PRINTING

WITH THERMOPLASTIC POLYURETHANE  
(TPU) ON THE HP JET FUSION 5210 LINE

Instructions for startups, studios, and producers

# Contents

<b>Introduction</b>	<b>3</b>
<b>General requirements to 3D models</b>	<b>4</b>
Surface intersection	4
Minimum thickness and edges	4
Gaps between parts	5
Movable joints	5
Volumetric products	6
Text and emboss	6
Grids and solid-state elements	7
Products for gluing and assembly	7
Making air lines and channels	8
Minimum thicknesses, gaps, and diameters	9
<b>File specifications</b>	<b>10</b>
File formats	10
File sizes	10
STL conversion errors	10
Model detailing	11
Preparing items with rounded edges for printing	11
<b>Common problems</b>	<b>12</b>
An incorrect ratio of side dimensions, wall thickness, and rigidity	12
Warping of flat parts	13
Warping of internal partition	13
Warping of thin-walled elements due to hot air release	14

# INTRODUCTION

Having a correct 3D model is key to ensuring your finished product complies with your requirements. If there are design mistakes, it takes more time to print products, their durability and appearance suffer, and movable parts may be baked into one.

We will tell you about the basic rules of model design for printing on the HP Jet Fusion 5210 printer.

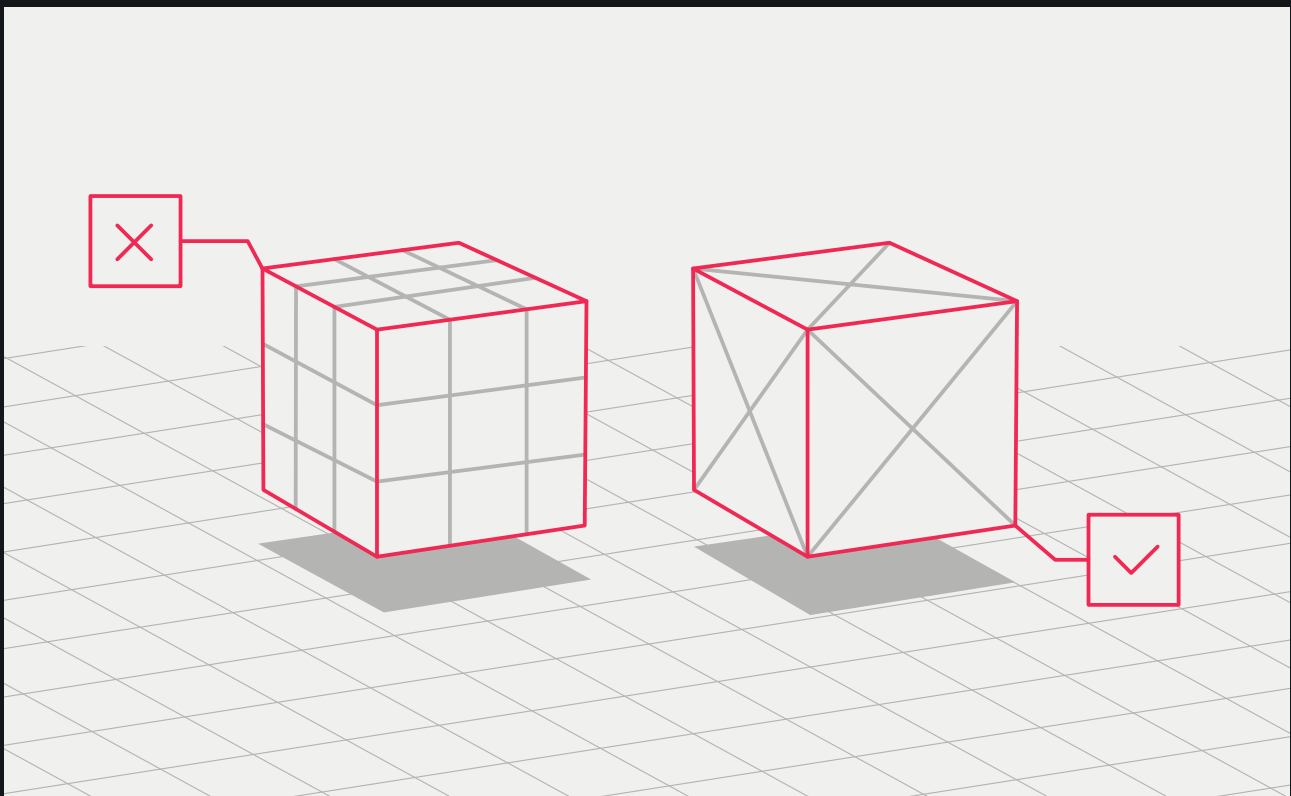

# GENERAL REQUIREMENTS FOR 3D MODELS

## Surface intersection

If the surface is made of several objects, they should be combined in the model for the finished part to have a continuous external shell. Otherwise, the non-printable surface wall will end up extremely thin and the second object will appear inside the first object.

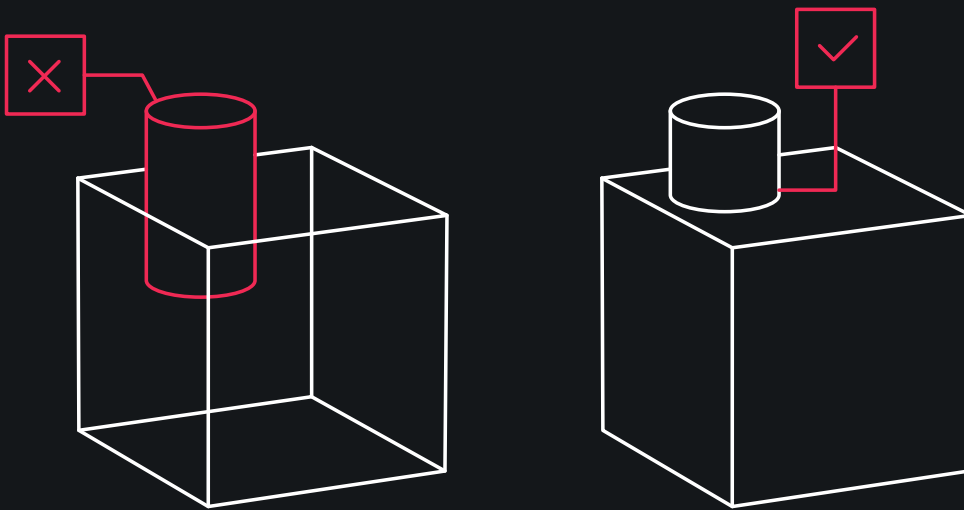

## Minimum thickness and edges

Any surface will have a thickness of **0.5 mm** or more. The product's durability, including its sharp edges, depends on it. Thin angles below **10°** may not be printed or may break during processing.



## — Gaps between parts

When printing products comprising multiple parts, sufficient clearance must be maintained between them. Otherwise, polymer powder will get between the parts, fusing them tightly into a single piece. The minimal clearance for printing on HP Jet Fusion 5210 is **0.4 mm** per dimension ( $\pm 0.2$  mm tolerance per side).

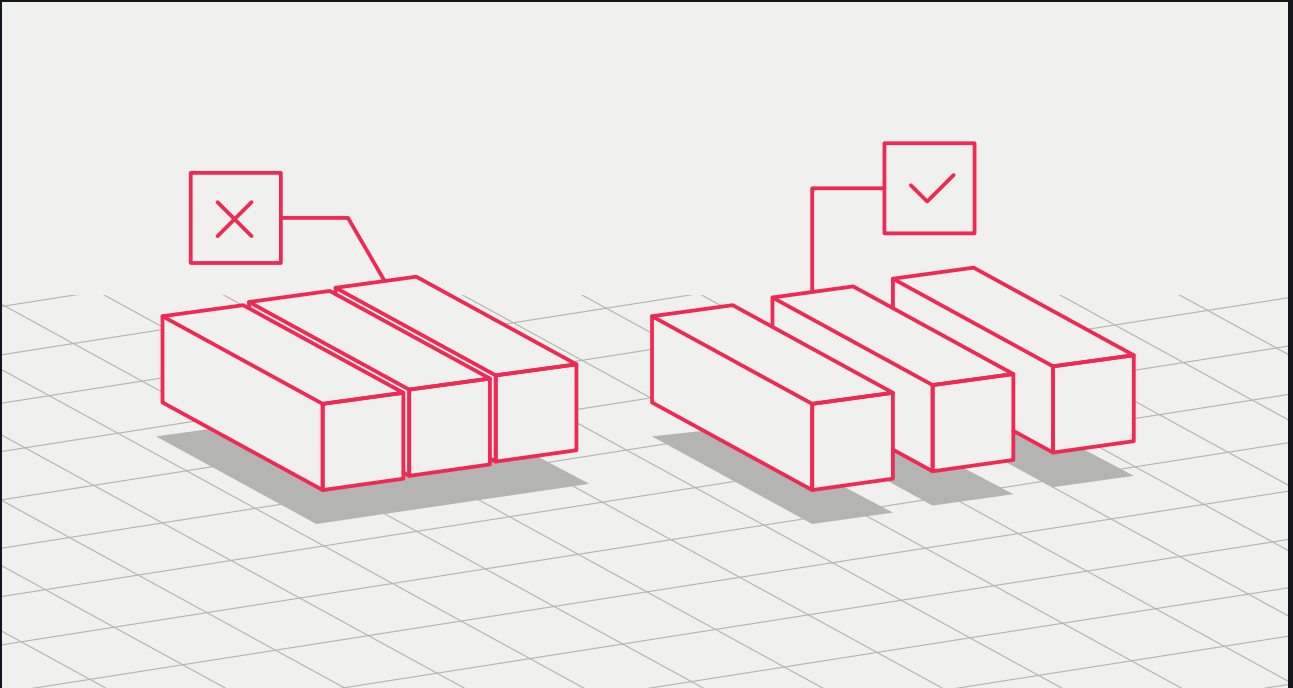

## — Movable joints

If you print movable joints, the gaps for alignment must be at least **0.5 mm**. Parts with wall thicknesses over **50 mm** must have a wider clearance (**+0.5 mm** clearance per **10 mm** of wall thickness) to ensure proper mobility.

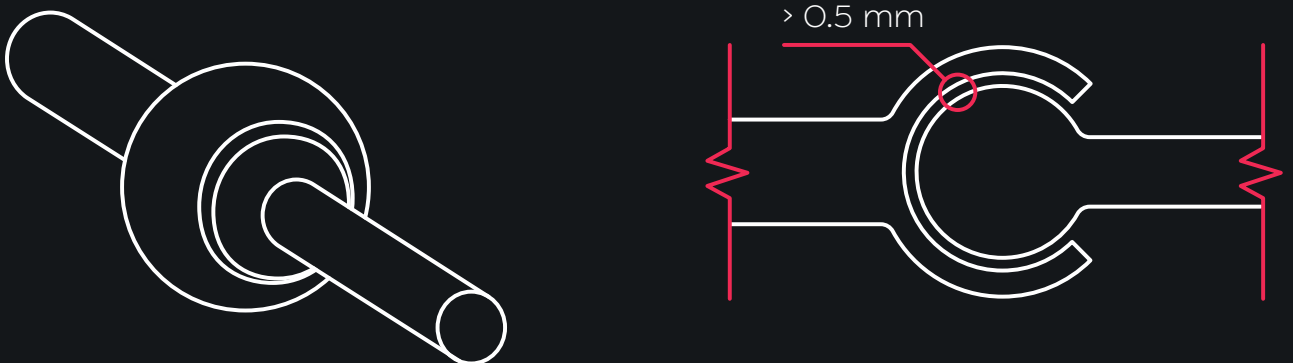

## Volumetric products

The weight of parts can be reduced by modeling them to be hollow. It is recommended to leave at least two **5–7 mm** diameter holes per **100 sq mm** to remove residual material.

The minimum hole diameter when printing on HP Jet Fusion 5210 is **0.5 mm**.

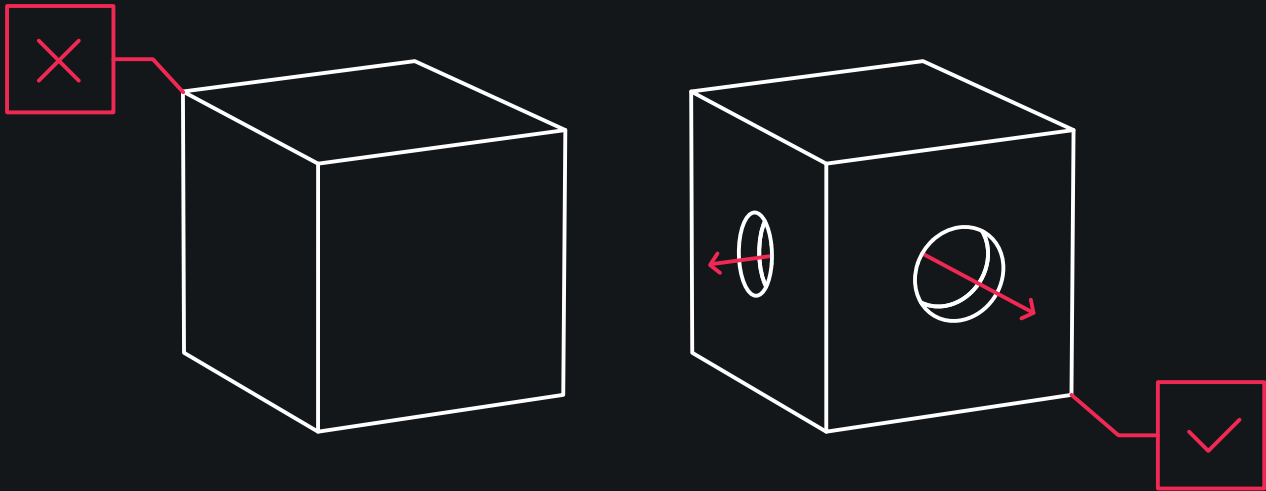

## Text and emboss

Please consider the minimum allowable parameters for protrusion or depression. If the sizes are below the minimum, the printer will not be able to reproduce them precisely. Take into account that sharp edges of embossing will be removed during the product sanding.

The minimum height of a protrusion or depression for the part printing on HP Jet Fusion 5210 is **1 mm**. The part's text shall be aligned in the XY plane, and the font size shall be **6 points** or more.

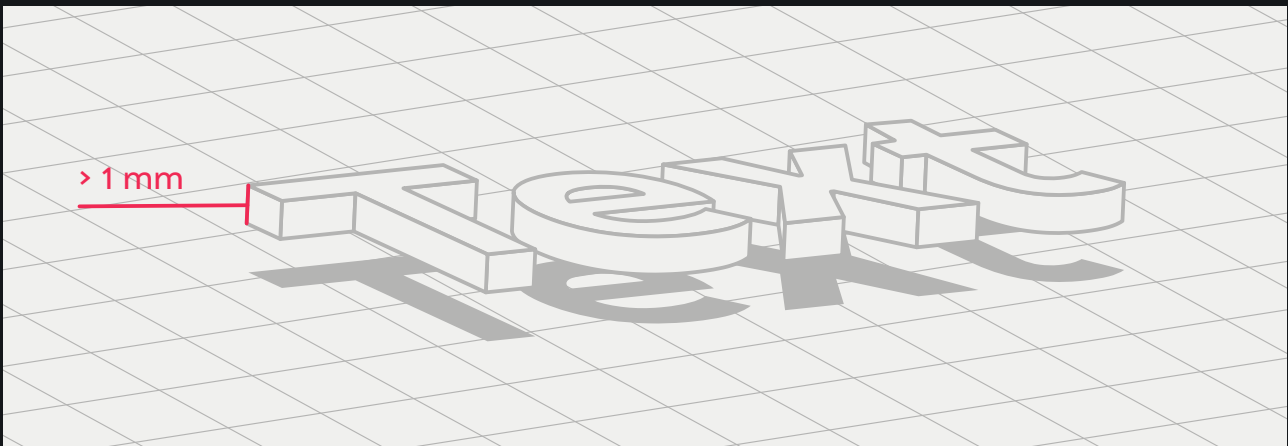

## Grids and solid-state elements

To create solid-state elements and large objects inside cavities, it is recommended to design a grid. This will ensure structural rigidity, make the part lighter, and reduce printing material consumption.

Products with grid elements must be designed while taking into account the minimum grid spacing. For printing on HP Jet Fusion 5210, this parameter must be at least **1 mm**.

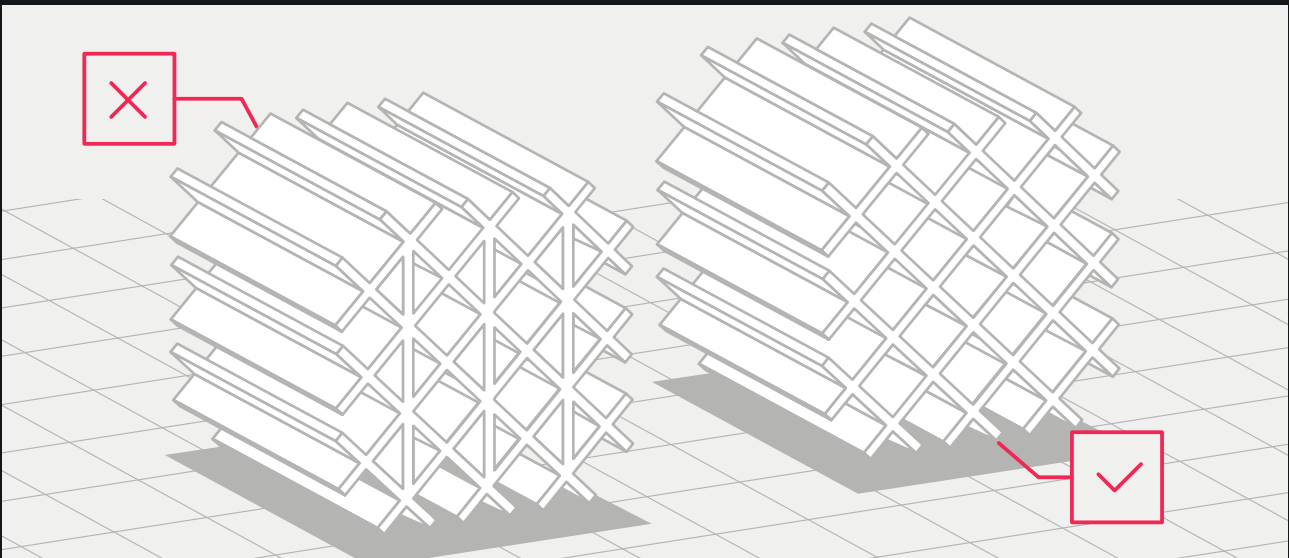

## Products for gluing and assembly

To ensure better buildability and the correct product size, allow for grooves in the joints and an assembly clearance of at least **0.2 mm**.

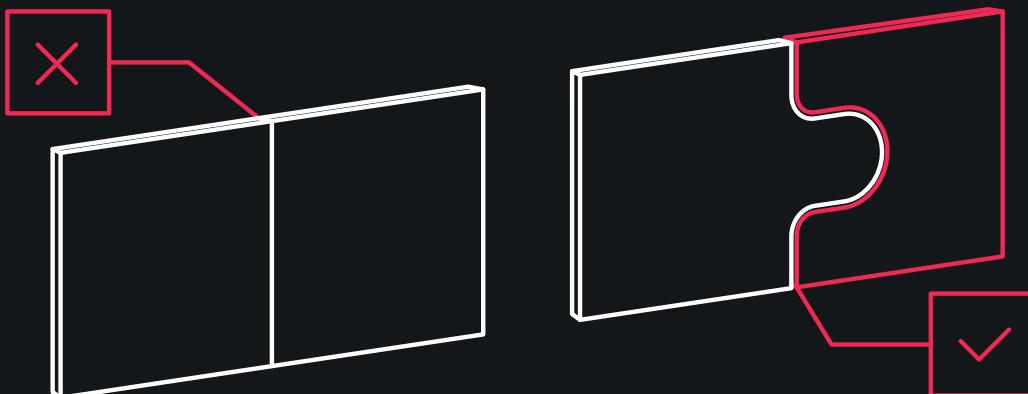

## — Making air-lines and channels

To avoid powder residue in the air-lines, we recommend designing a chain or central vein inside them. The minimum size of an air duct or pipe part is **20 mm**. Consequently, the minimum chain diameter is **5 mm**. These types of channels must be open so that powder can be removed. The chain can be removed from the part after printing and material removal.

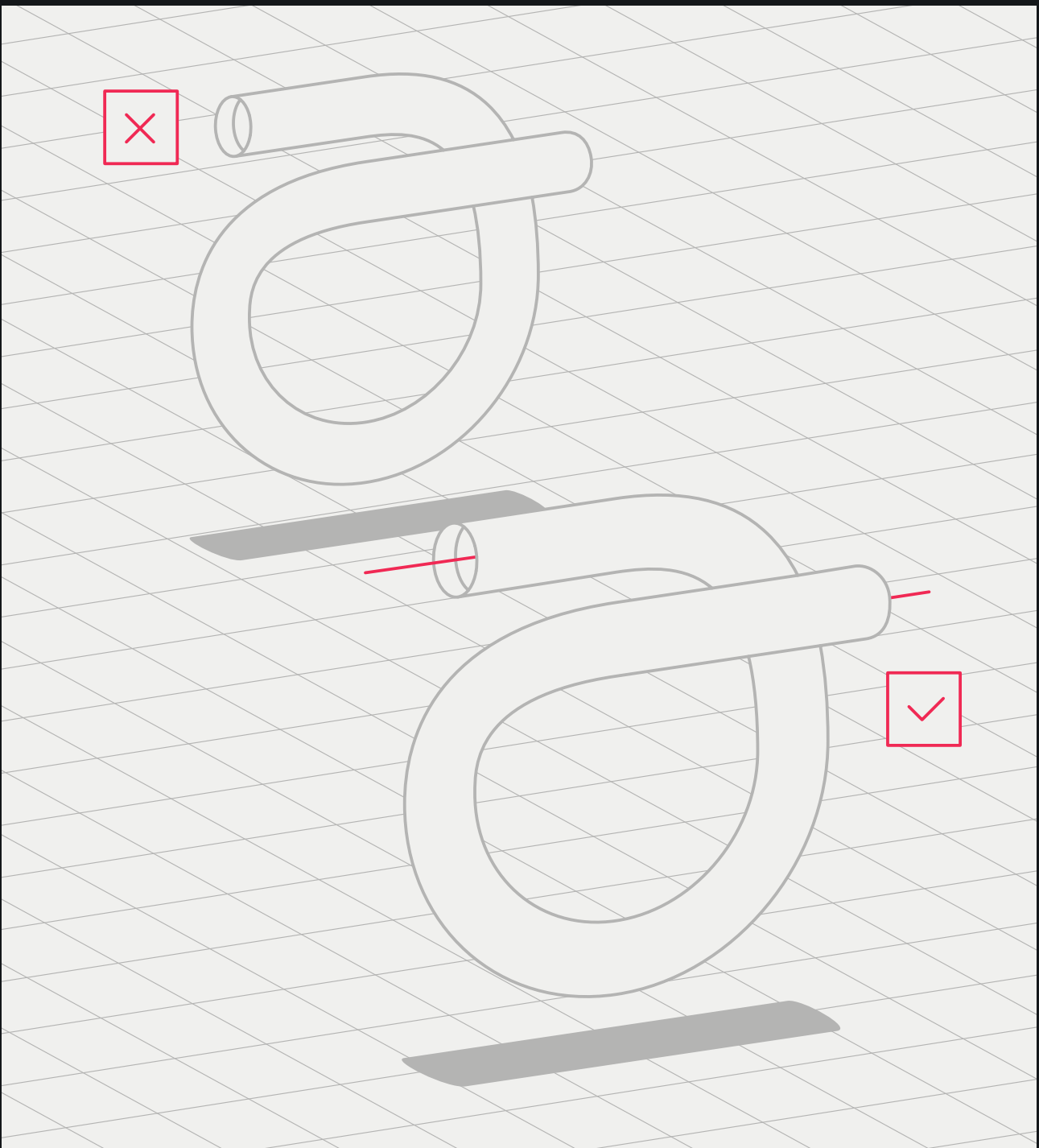



## Minimum thicknesses, gaps, and diameters

Part element	Limit
Wall thickness	≥ 0.5 mm
Hole diameter at a wall thickness of 1 mm	≥ 0.5 mm
The protrusion (arm) diameter with a height of 10 mm	≥ 0.5 mm
Gap between the parts with a thickness of 1 mm	≥ 0.5 mm
Font for printing	6 points and more
Gap between walls	≥ 0.5 mm
Protrusion (depression) height	≥ 1 mm
Grid spacing	≥ 1 mm

## Technology tolerances

Nominal size, mm	1-3	3-6	6-10	10-18	18-30	30-50	50-80	80-120
Standard tolerance values, mm	0.14	0.18	0.22	0.27	0.33	0.39	0.46	0.54

# FILE SPECIFICATIONS

## File formats

Slicer software (from the word 'to slice') is used to turn a 3D model into the print control code. This software disassembles the model into layers used by the printer for the model building. HP Jet Fusion 5210 supports only 3D models in **.stl** format.

## File sizes

On average, a model weighs **1–25 MB**. The file size depends on the polygon number and the software it was designed in. Additional data, such as angle tolerance and degree of deflection, is often required for export to STL packs. These parameters determine the file extension and size.

## STL conversion errors

Before sending a task to a 3D printer, you need to create a printing model. The object should consist of **triangular polygons** which are used by the printer to create layers them. Models with rectangular and polygonal polygons are not suitable for printing. The excess detailing of a 3D model increases its processing time but does serve any useful purpose.

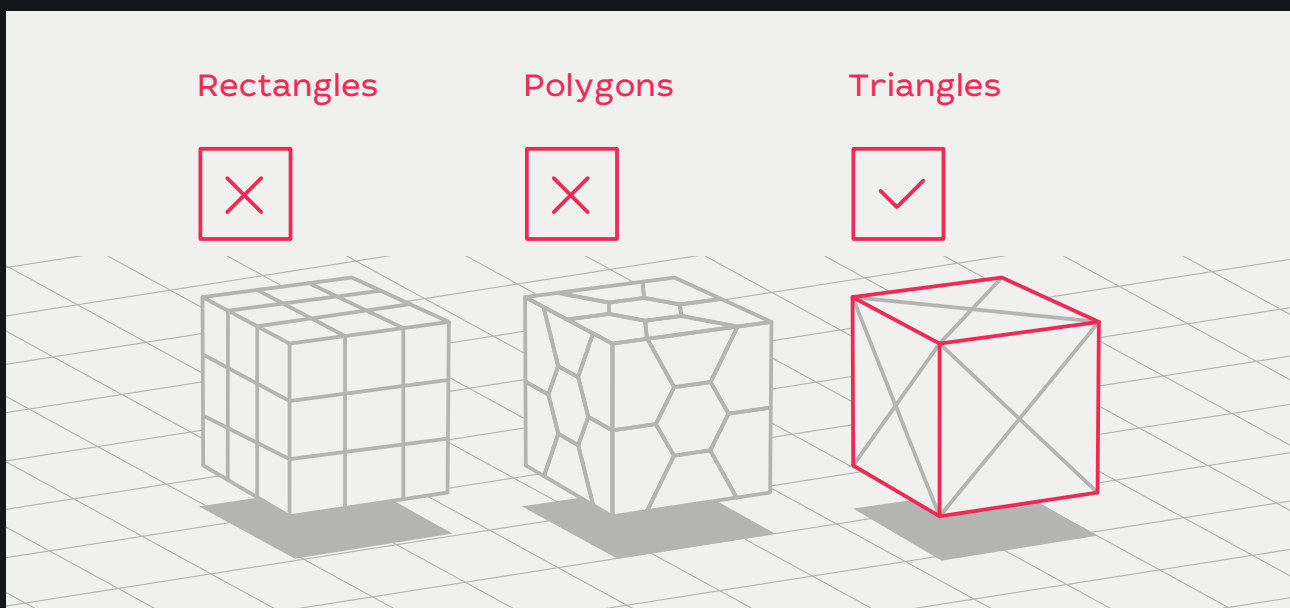

## Model detailing

The surface triangulation leads to a three-dimensional model faceting. The parameters used for the model output in the .stl format affect the faceting degree.

When saving models as .stl files, click Options and select ASCII encoding. The recommended quality values for the Distance and Angle field are a tolerance of **0.05** and an angle of **1°**. The angle can vary by up to 10° to reduce the file size if you don't mind reduced surface quality or level of detail.

## Preparing items with rounded edges for printing

Since items are printed layer by layer, those with rounded edges may have visible lines on their surfaces. To avoid that, we recommend taking the following steps:

1. Mark the model surfaces that require special attention.
2. Provide design documentation for accurate dimensions.

# COMMON PROBLEMS

## — An incorrect ratio of side dimensions, wall thickness, and rigidity

Hollow pieces with thin walls can deform unless given additional support during printing. Therefore, we recommend printing these pieces with a strong internal frame to support the side frames.

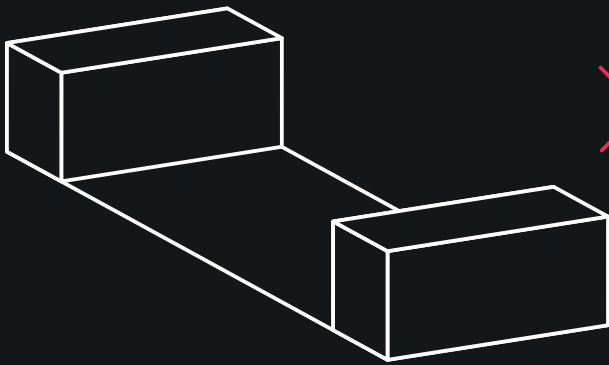

Layout view

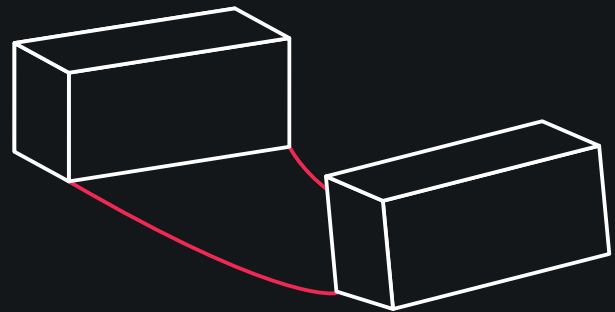

View after printing

Dimensions: 337 x 63 x 307 mm

Wall thickness: 2.5 mm

**Solution:**

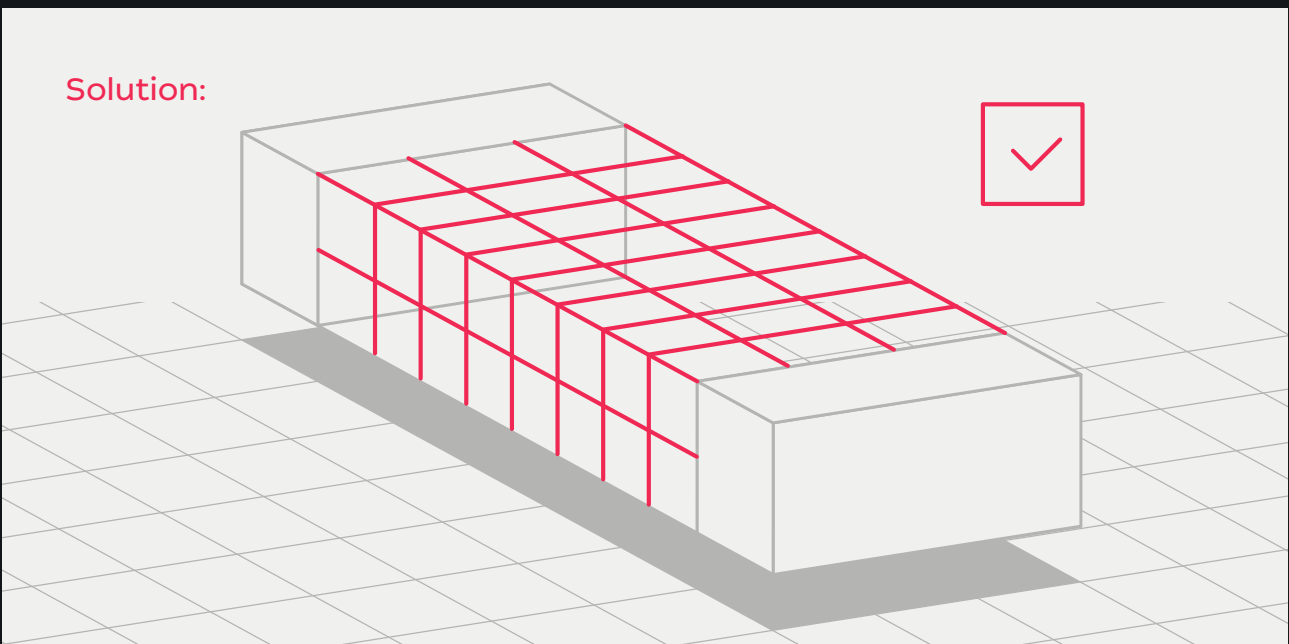

## Warping of flat parts

With this wall thickness (**1.2 mm**) the flat parts can warp, resulting in a deformed product. To avoid this, we recommend designing your items with at least **5 mm** wall thickness, as anything less poses the risk of warping.

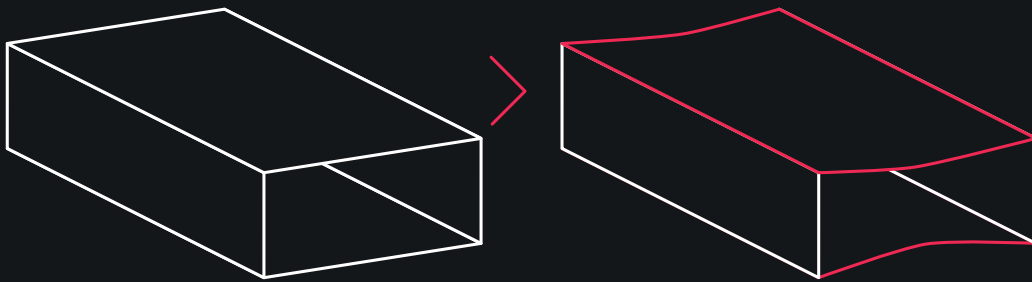

Layout view

View after printing

Dimensions: 147 x 222 x 66 mm

A printed piece with a 1.2 mm wall thickness

## Warping of internal partition

An insufficient wall thickness can result in a deformed internal partition. We recommend that you account for this possibility when creating a 3D model by designing internal structures with a wall thickness of at least **0.8 mm**.

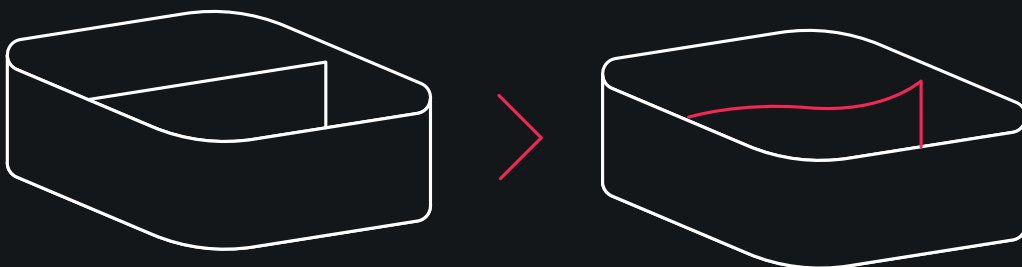

Layout view

View after printing

Dimensions: 81 x 80 x 34 mm

Wall thickness: 0.25 mm

## — Warping of thin-walled elements due to hot air release

When printing large models with thin walls, the finished item can be deformed by hot air being released from a closed space and boiling the item from the inside. To avoid this, we recommend separating large models wherever possible. This will permit the safe removal of the powder during post-processing and properly release hot air when printing.

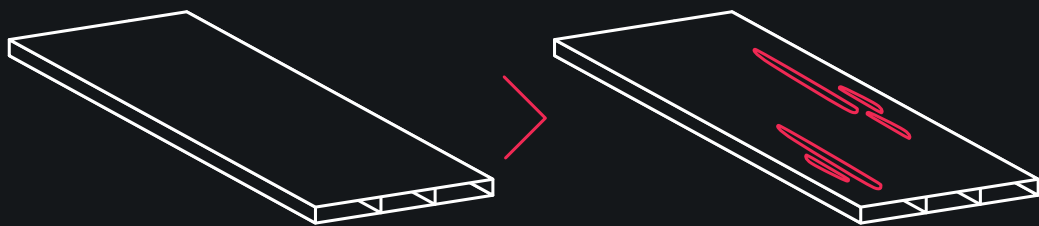

Layout view

View after printing

Dimensions: 155 x 378 x 32 mm

Wall thickness: 1.5 mm

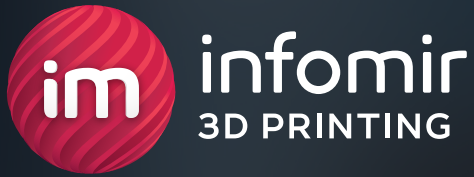

## **INFOMIR 3D PRINTING – PRECISION EMBODIMENT OF YOUR IDEAS!**

**+380 (99) 075 59 95**

**3dprint@infomir.com**

**facebook.com/infomir.eu**

**instagram.com/3dprint\_infomir**

**Visit site**